

Angles

1.- Amb el transportador d'angles mesureu els angles següents:

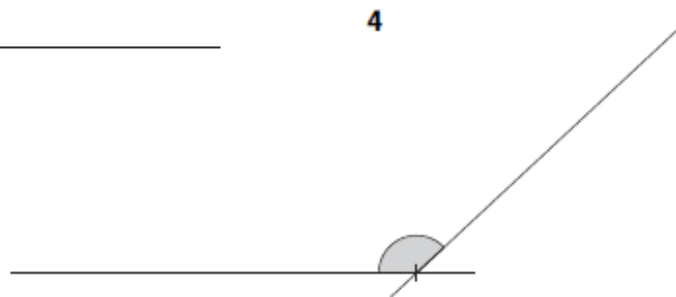
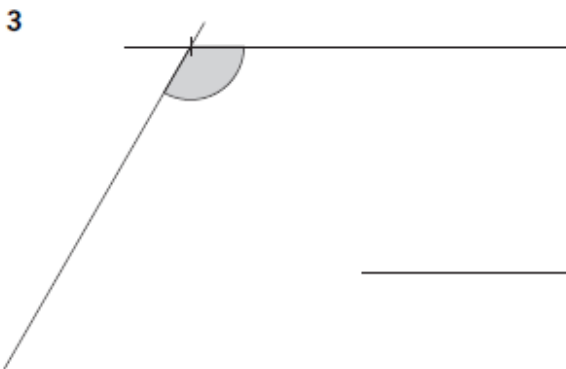
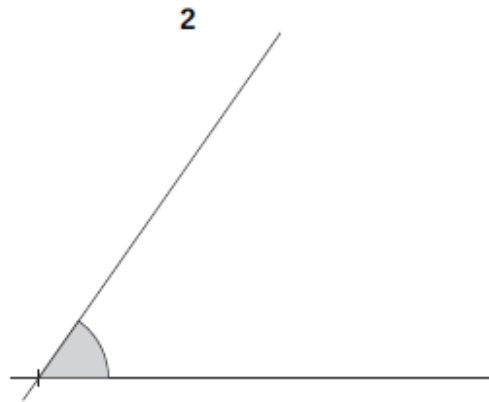
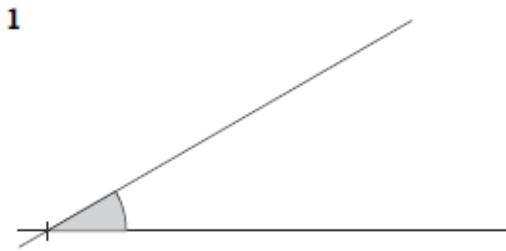

2.- Dibuixeu els següents angles:

a) 75°

b) 145°

23°

3.- Mesureu els angles dels següents triangles:

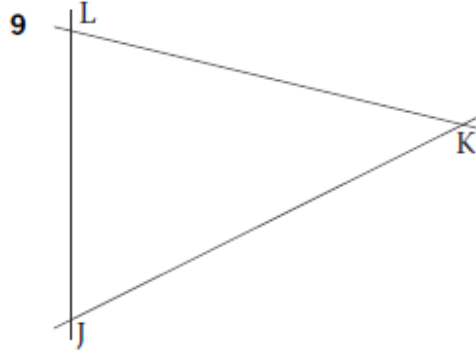
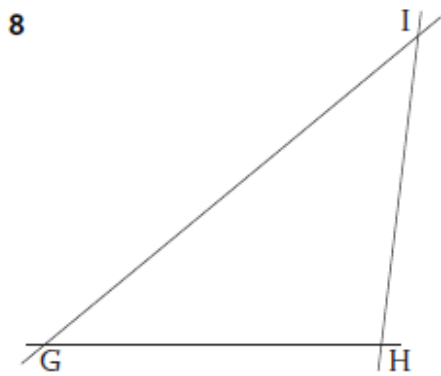
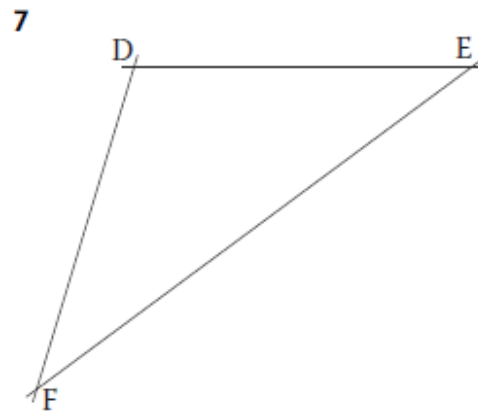
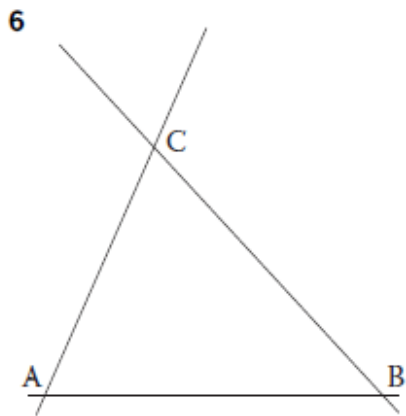

4.- Calculeu els angles desconeguts:

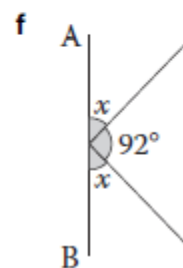
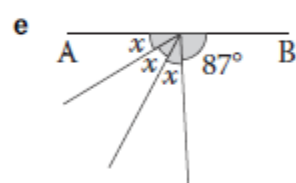
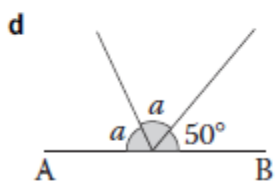
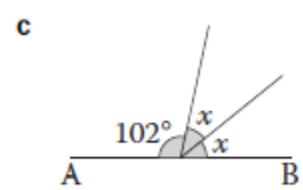
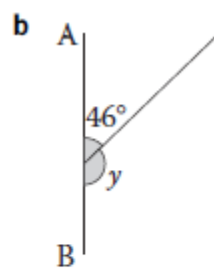
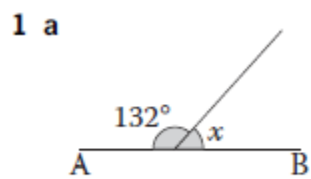

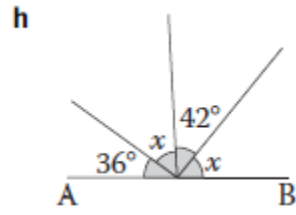
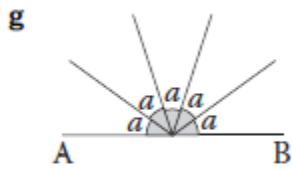

5.- Calculeu els angles desconeguts:

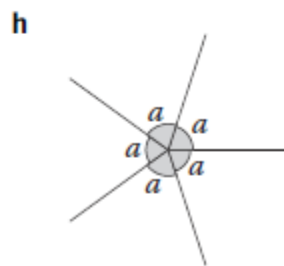
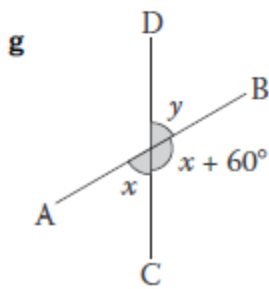
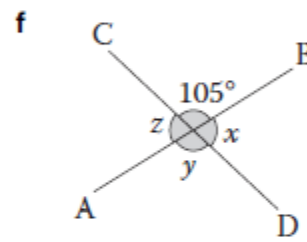
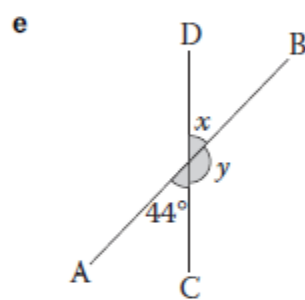
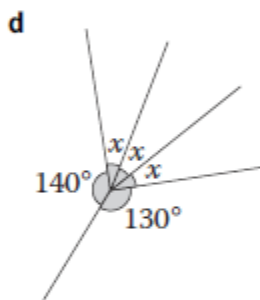
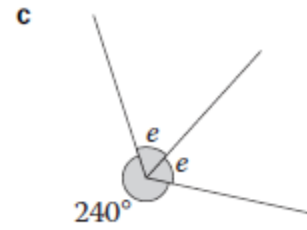
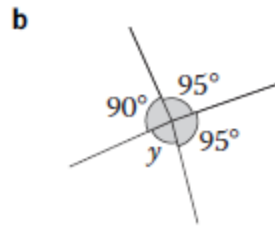
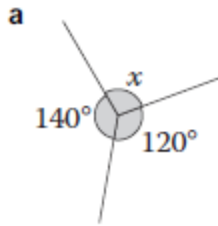

Angles entre paral·leles.

Siguen a i b dues rectes paral·leles.

Siga r una recta transversal (que talla a les anteriors).

La intersecció de les dues rectes forma 8 angles.

Els angles són iguals o suplementaris:

- a) $\angle 1 = \angle 4 = \angle 5 = \angle 8$.
- b) $\angle 2 = \angle 3 = \angle 6 = \angle 7$.
- c) $\angle 1 = 180^\circ - \angle 2 = 180^\circ - \angle 3$.

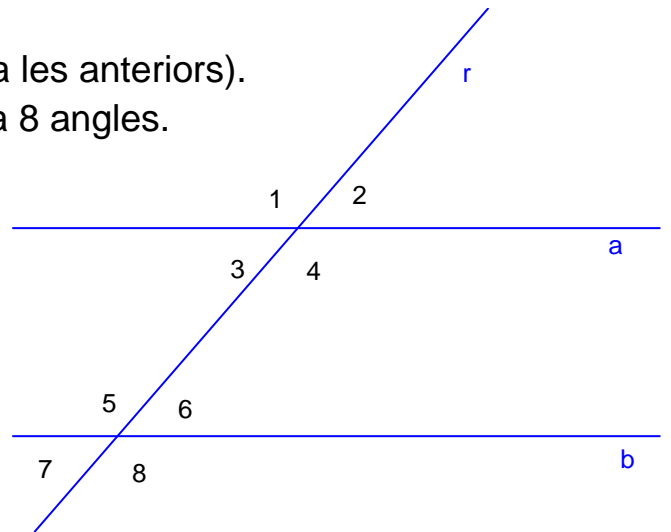

Exercici:

Calcule els angles desconeguts:

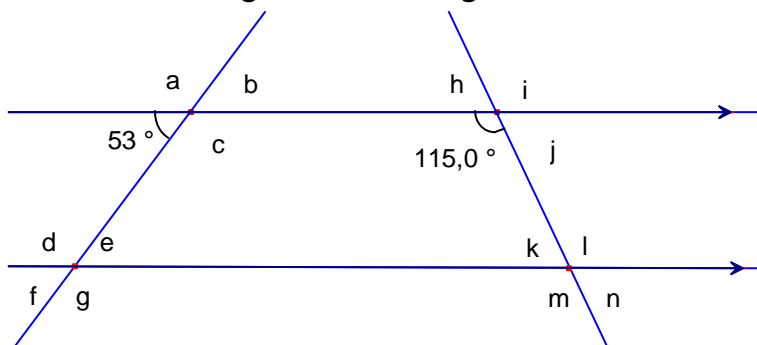

Solució:

$$b = e = f = 53^\circ.$$

a, c, d, g són suplementaris de 53° .

$$a = c = d = g = 180^\circ - 53^\circ = 127^\circ.$$

$$i = m = l = 115^\circ.$$

h, j, k, n són suplementaris de 115° .

$$h = j = k = n = 180^\circ - 115^\circ = 65^\circ.$$

6.- Calculeu els angles desconeguts:

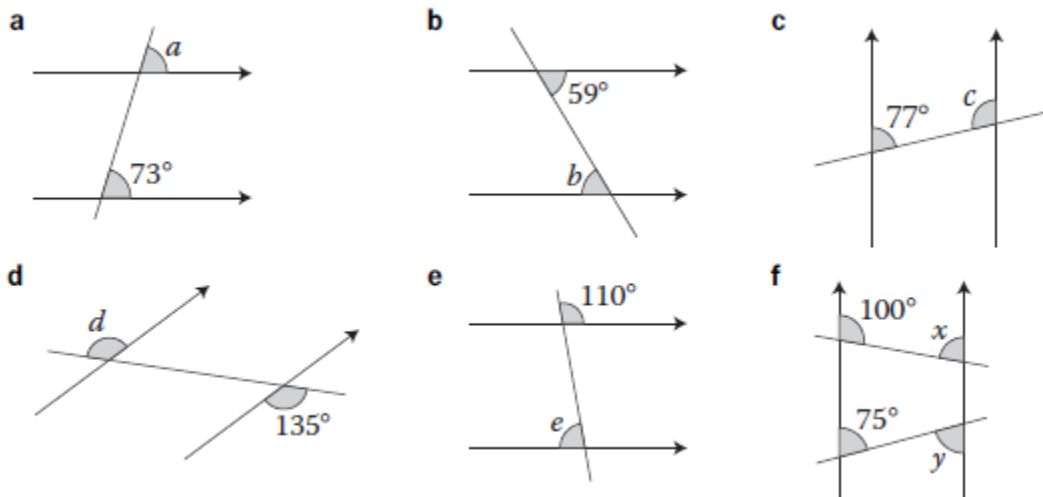

7.- Calculeu els angles desconeguts:

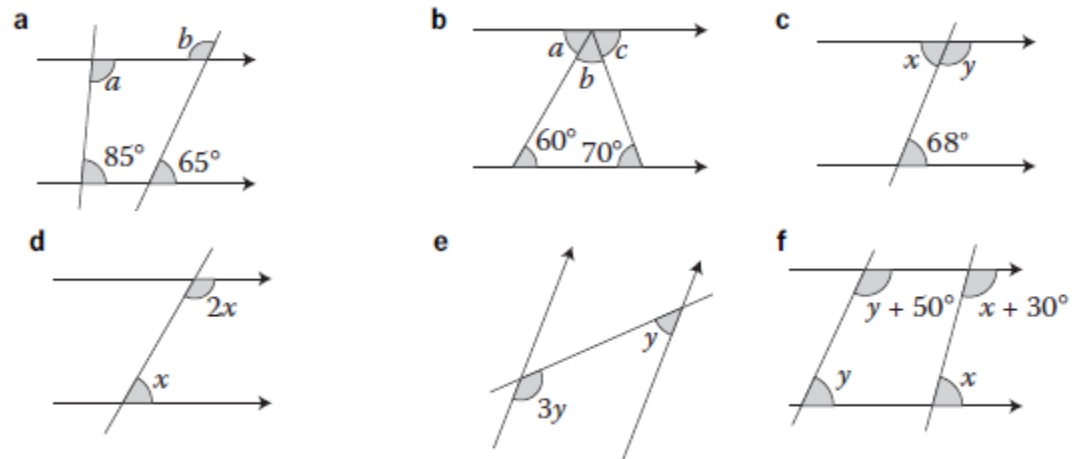

8.- Calculeu els angles desconeguts:

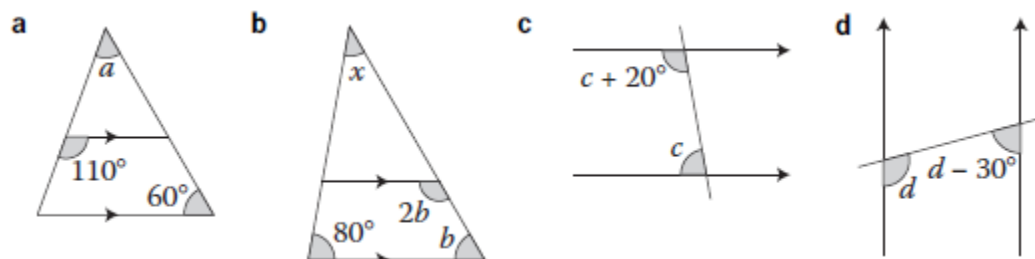

9.- Calculeu l'angle que falta del triangle.

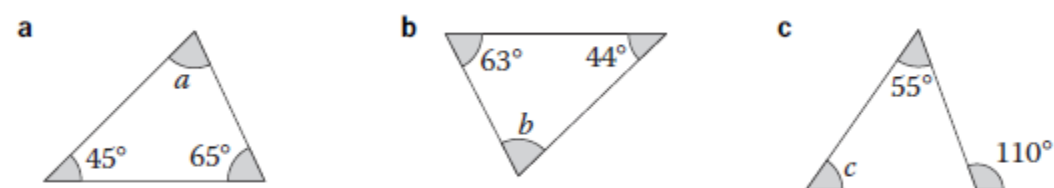

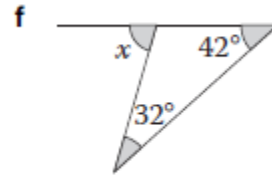
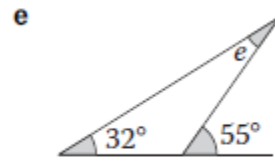
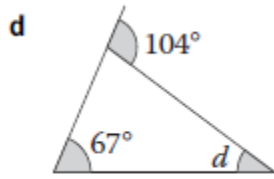

10.- Calculeu l'angle que falta del triangle.

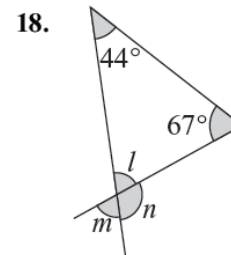
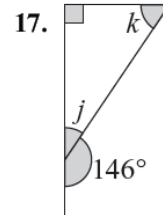
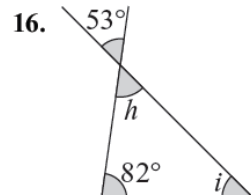
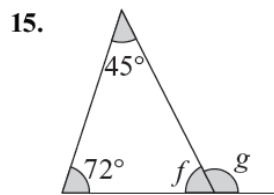
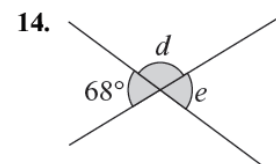
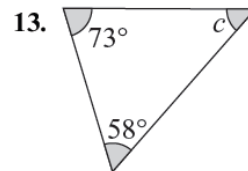
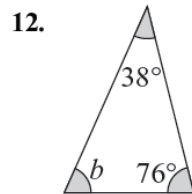
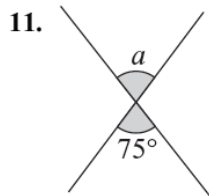
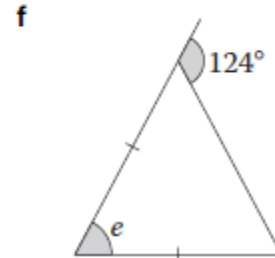
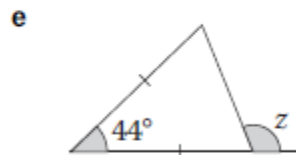
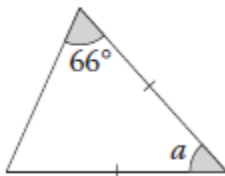
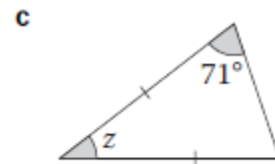
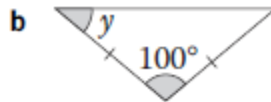
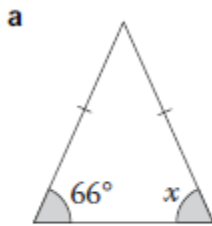

11.- Suma dels angles d'un polígon convex.

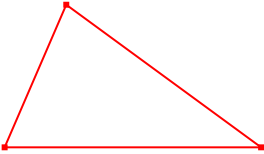
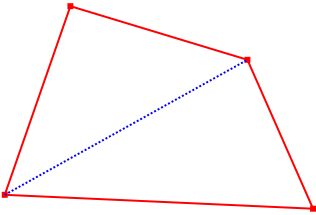
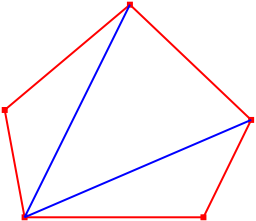
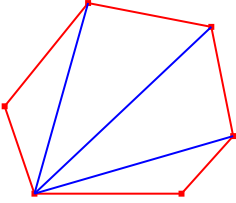
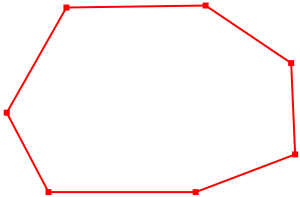
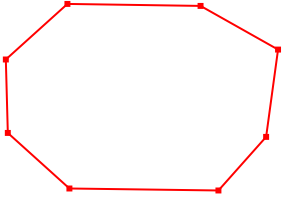
Polígon	Suma dels angles
	180°
	$2 \cdot 180^\circ = 360^\circ$
	$3 \cdot 180^\circ = 540^\circ$
	
	
	
<p>Polígon de n costats</p>	

12.- Angle central i angle inscrit d'un polígon regular convex

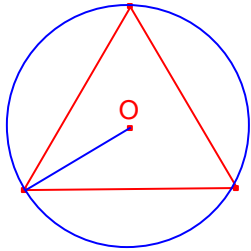
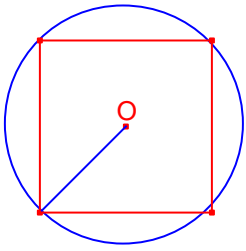
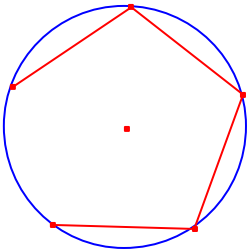
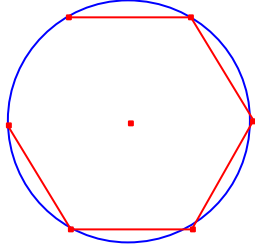
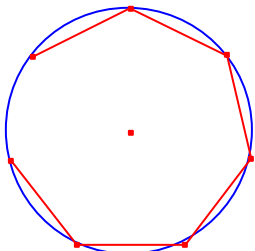
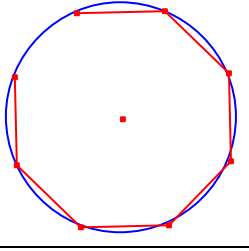
Polígon	Angle central	Angle inscrit
	$\frac{360^\circ}{3} = 120^\circ$	$\frac{180^\circ}{3} = 60^\circ$
	$\frac{360^\circ}{4} = 90^\circ$	$\frac{180^\circ \cdot 2}{4} = 90^\circ$
	$\frac{360^\circ}{5} = 72^\circ$	$\frac{180^\circ \cdot 3}{5} = 108^\circ$
		
		
		
Polígon de n costats		

11.- Calculeu l'angle que falta del quadrilàter.

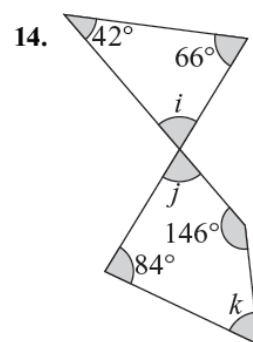
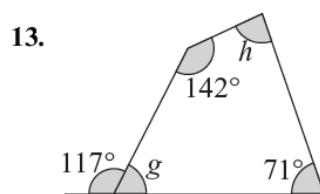
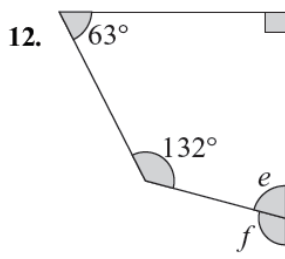
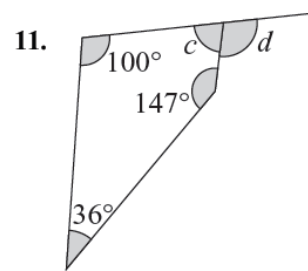
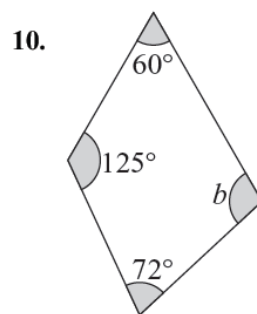
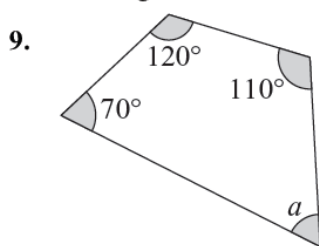
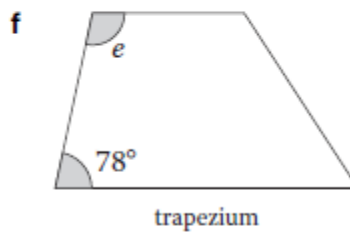
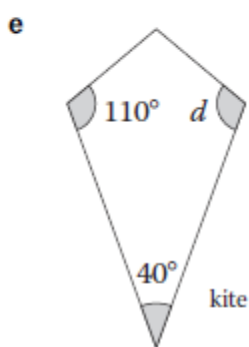
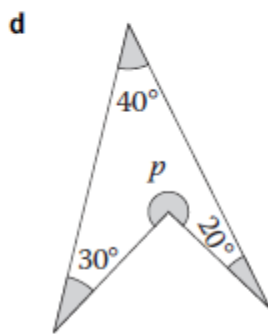
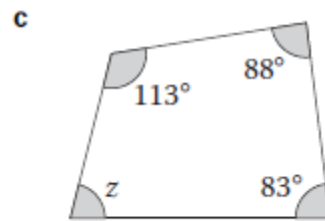
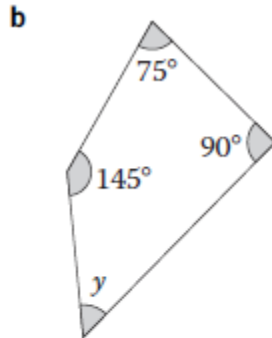
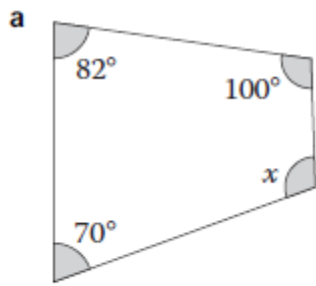

Angles de la circumferència:

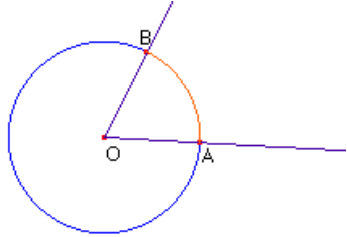
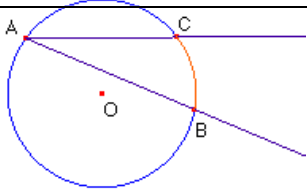
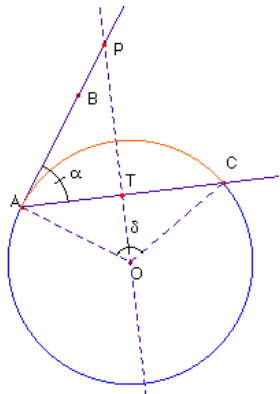
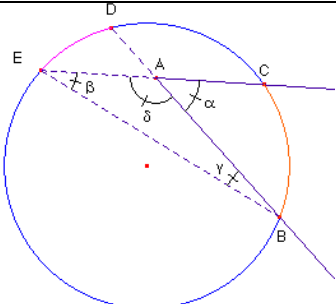
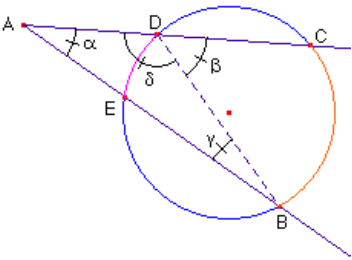
Angle	Definició		Mesura
Central	S'anomena angle central $\angle AOB$, l'angle el vèrtex del qual és el centre de la circumferència i els seus costats contenen radis. El conjunt dels punts de la circumferència interiors a l'angle s'anomena arc de la circumferència.		L'angle central mesura el mateix que l'arc que abraça.
Inscrit	S'anomena angle inscrit $\angle BAC$, l'angle el vèrtex del qual és un punt de la circumferència, i els costats són dues cordes de la mateixa.		L'angle inscrit d'una circumferència, mesura la meitat que l'arc que abraça.
Semiinscrit	S'anomena angle semiinscrit $\angle BAC$, l'angle el vèrtex del qual és un punt de la circumferència, un costat és una corda i l'altre costat és tangent a la circumferència.		L'angle semiinscrit mesura la meitat de l'arc de circumferència que abraça.
interior	S'anomena angle interior $\angle BAC$, l'angle el vèrtex del qual és un punt interior de la circumferència, i els costats són cordes de la circumferència.		L'angle interior mesura la semisuma dels arcs que abraça.
exterior	S'anomena angle exterior $\angle BAC$, l'angle el vèrtex del qual és un punt exterior a la circumferència, i els costats són cordes o rectes tangents de la circumferència.		L'angle exterior, mesura la semidiferència dels arcs que abraça.

12.- Calculeu els angles desconeguts

1

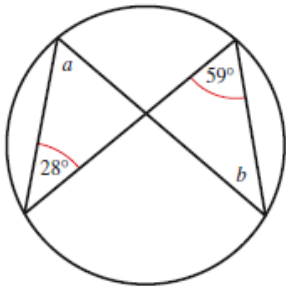

2

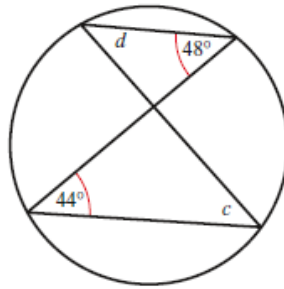

3

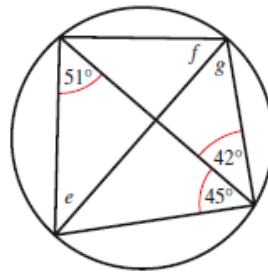

4

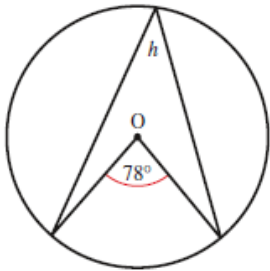

5

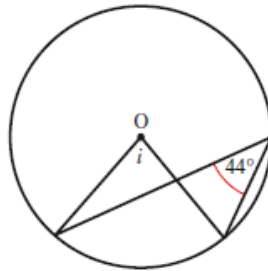

6

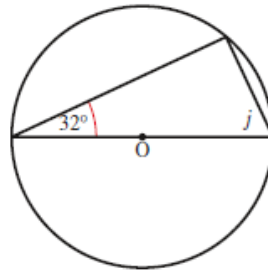

7

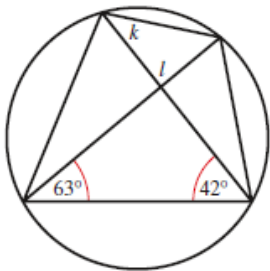

8

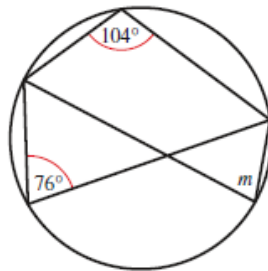

9

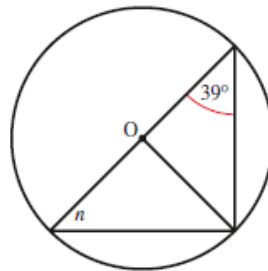

10

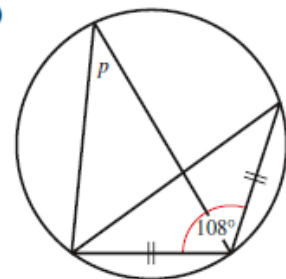

11

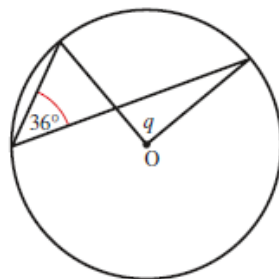

12

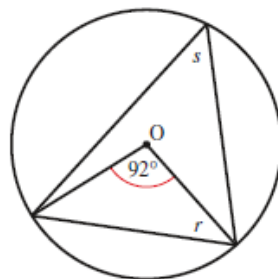

13

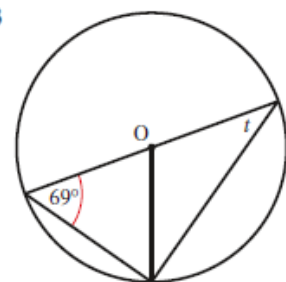

14

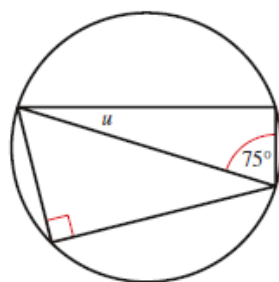

15

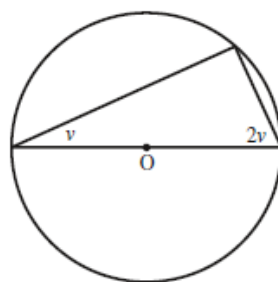

13- Calculeu els angles desconeguts

