

Àrees i volums de cossos geomètrics.

1.- Calculeu l'àrea dels següents cossos:

a)

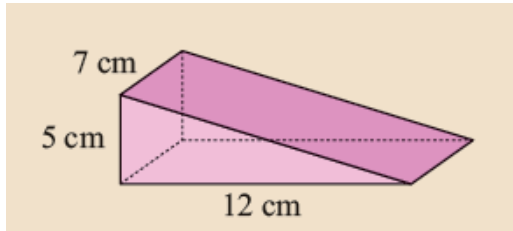

b)

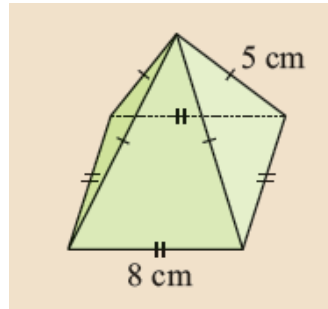

2.- Calculeu l'àrea dels següents cossos:

a

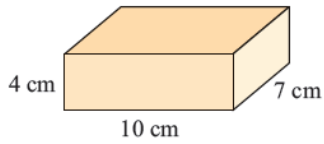

b

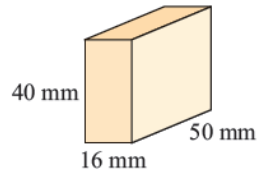

c

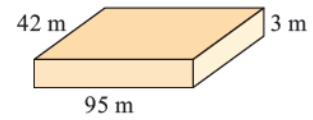

a

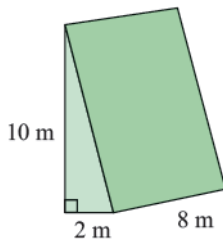

b

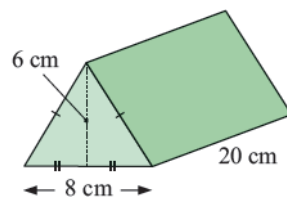

c

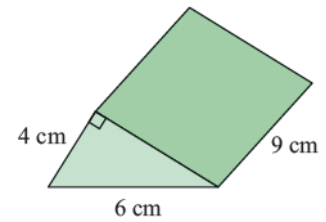

3.- Calculeu l'àrea dels següents cossos:

a

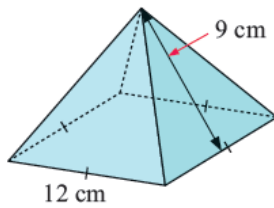

b

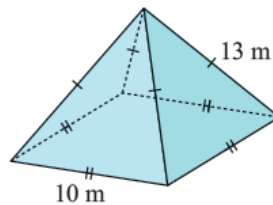

c

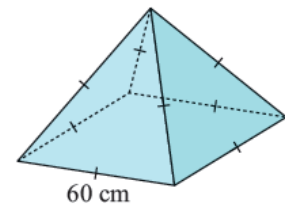

4.- Calculeu l'àrea dels següents cossos:

a

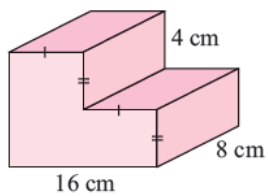

b

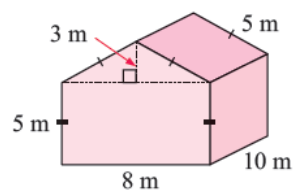

c

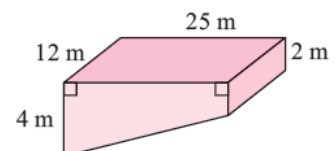

5.- Calculeu l'àrea dels següents cossos:

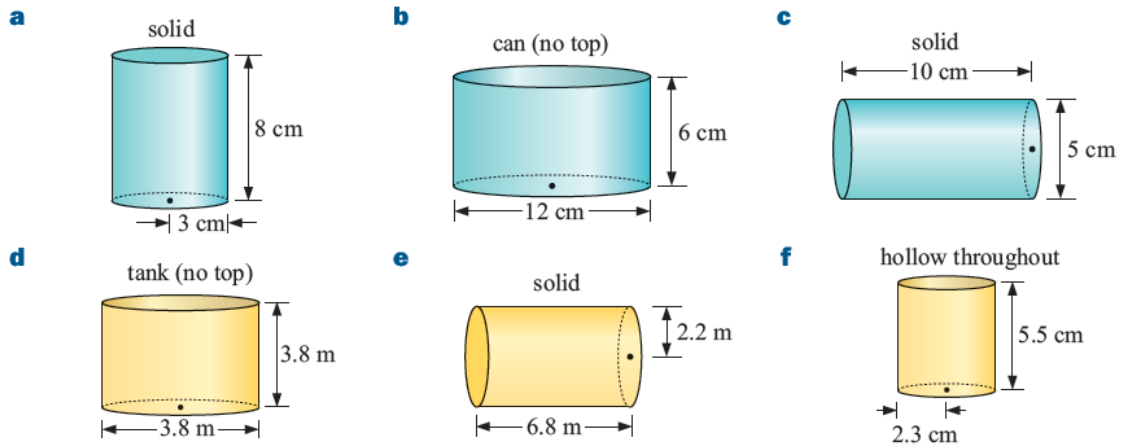

6.- Calculeu l'àrea dels següents cossos:

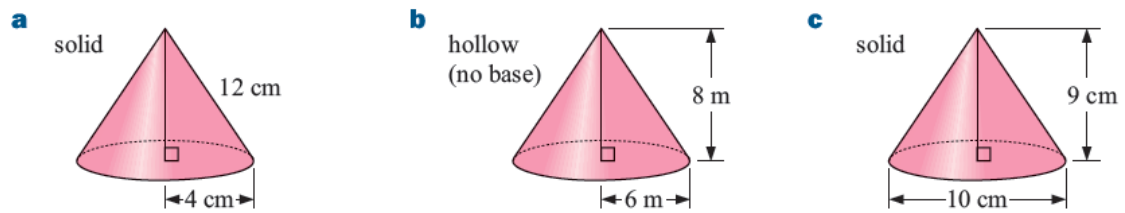

7.- Calculeu l'àrea dels següents cossos:

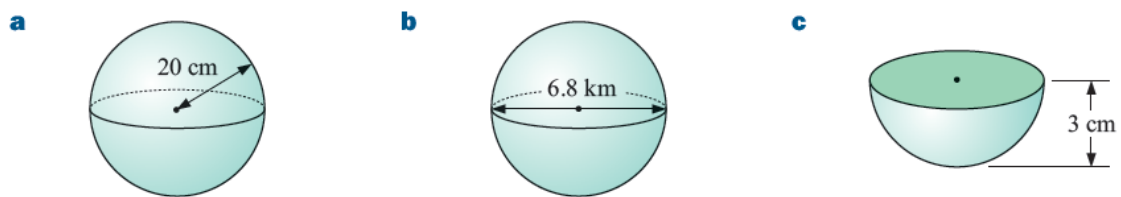

8.- Calculeu el volum dels següents cossos

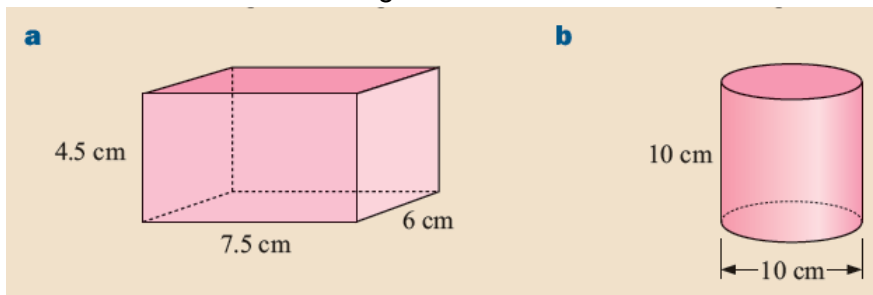

9.- Calculeu el volum dels següents cossos

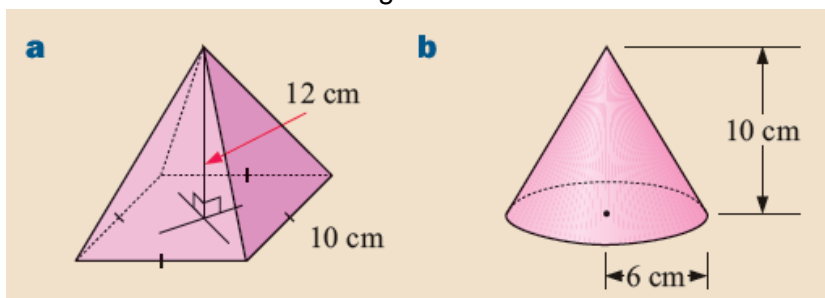

10.- Calculeu el volum dels següents cossos

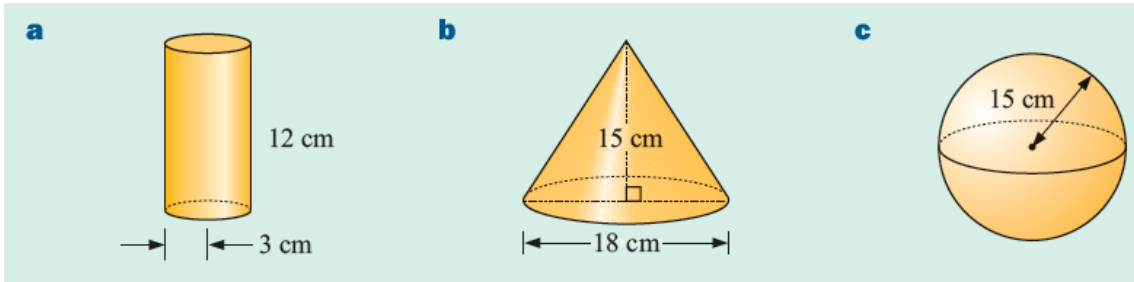

11.- Calculeu el volum dels següents cossos

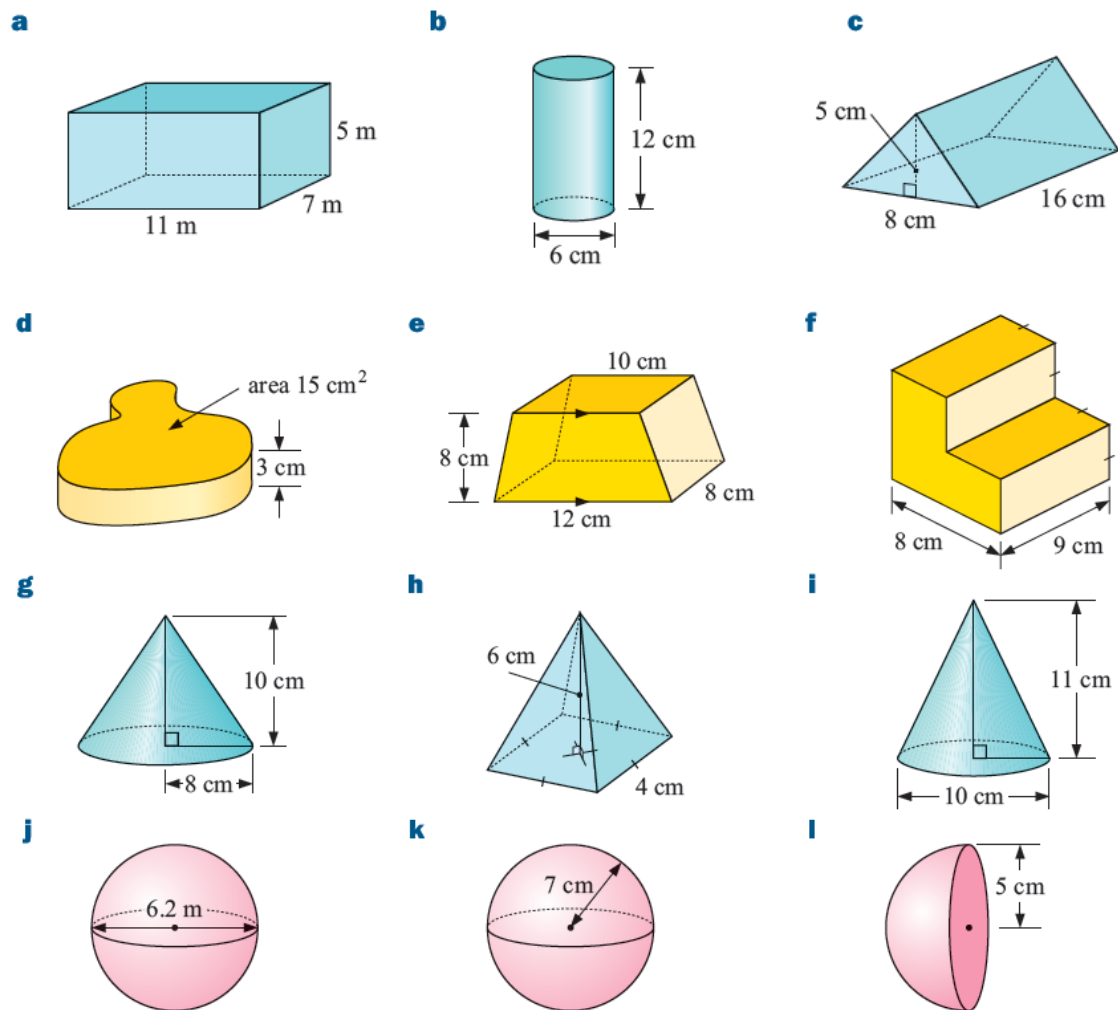

12.- Calculeu l'àrea i el volum del següent cos

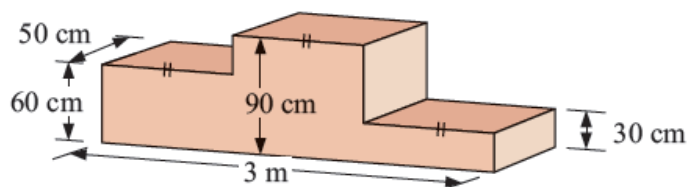

13.- Calculeu l'àrea i el volum dels següents cossos

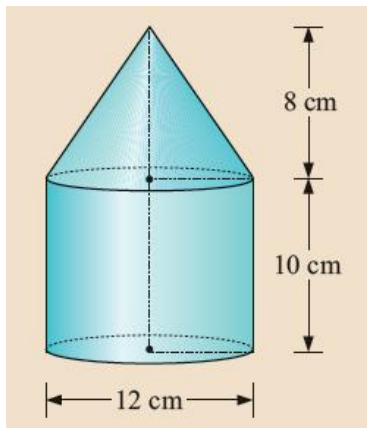

a)

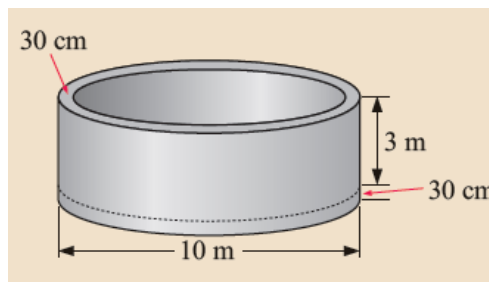

b)

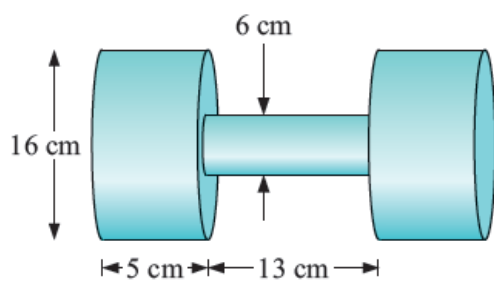

c)

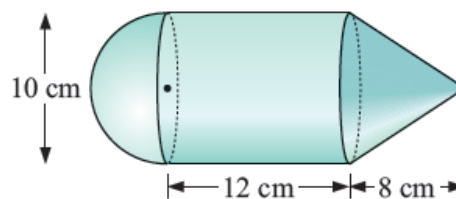

d)